

GENERAL DESCRIPTION

The MX6288T is a cost effective, single P-MOSFET load switch with ultra-low RDS(ON), optimized for self-powered and bus powered Universal Serial Bus applications.

Input voltage from 2.5V to 5.5V, making it ideal for both 3.3V and 5V systems. A built-in P-channel MOSFET with true shutdown function to eliminate any reversed current flow across the switch. When output voltage is higher than input voltage, power switch is turned off.

The MX6288T offers a programmable current limit threshold between 200mA to 2.4A via an external resistor.

FEATURES

- ◆44mR Typical RDSON MOS is integrated
- ◆1μA Typical at Switch Off state
- ◆Wide Input Voltage Range: 2.5V to 5.5V
- ◆Fast Transient Response: 8μs
- ◆0.1ms Typical Rise Time
- ◆Reverse Current Flow Blocking
- ◆Automatic Output Discharge at Shutdown
- ◆Thermal Shutdown Protection
- ◆Hot Pluggable
- ◆Adjusted Enable
- ◆Sot23-5 Package available

APPLICATIONS

USB Bus / Self-powered Hubs
 Safety Equipment
 Battery Charger Circuits
 Personal Communication Devices
 Notebook Computers

GENERAL INFORMATION

Ordering information

Part Number	Description
MX6288T	SOT23-5, Halogen-free, T&R

Package dissipation rating

Package	RθJC (°C/W)	RθJA (°C/W)
SOT23-5	130	260

Absolute maximum ratings

Parameter	Value
Input Voltage Range	-0.3 to 7V
All other pins voltage range	-0.3 to VIN+0.3V
Junction temperature T _J	-40 to 150°C
Storage temperature T _{STG}	-55 to 150°C
Leading temperature (soldering, 10secs)	260°C
ESD Susceptibility HBM	2000V

Over Stress Caution

Stresses beyond those listed in Absolute Maximum Ratings may cause permanent damage to the device. Exposure to absolute maximum rating conditions for extended periods may affect reliability. Functional operation of the device at any conditions beyond those indicated in the Recommended Operating Conditions section is not implied.

This integrated circuit can be damaged by ESD if you don't pay attention to ESD protection. The MAXIN MICRO recommends that all integrated circuits be handled with appropriate precautions. Precision integrated circuits may be more susceptible to damage because very small parametric changes could cause the device not to meet its published specifications.

Recommended operating condition

Symbol	Parameter	Range
VCC	VCC supply voltage	2.5-5.5V
PD_MAX	@TA=25°C SOT23-5	0.4W

Typical Application

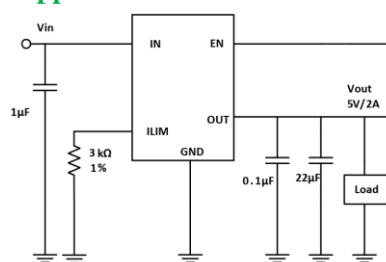

TERMINAL ASSIGNMENTS

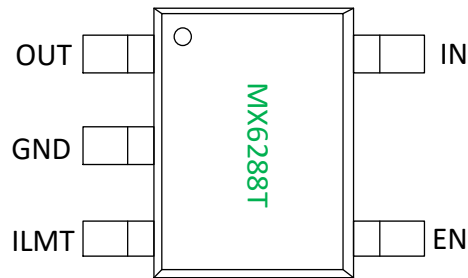

Figure5 pin information

PIN name	PIN No.	Description
OUT	1	Switch Output Pin
GND	2	Ground Pin
ILIM	3	Current limit Set Pin
EN	4	High Enable. Not floating
IN	5	Power Input Pin

BLOCK DIAGRAM

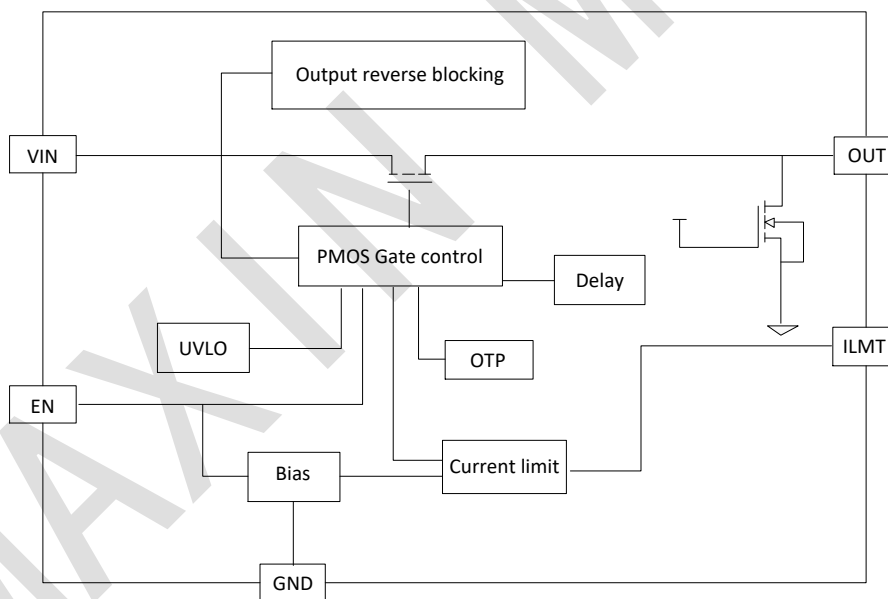

Figure6 block diagram

Electrical characteristics

($T_A=25^{\circ}\text{C}$, $V_{CC}=5\text{V}$, $C_L=1\mu\text{F}$, unless otherwise noted)

Symbol	PARAMETER	TEST CONDITIONS	MIN	TYP	MAX	UNIT
SUPPLY CURRENT						
V_{IN}	Input Voltage		2.5		5.5	V
I_Q	Quiescent Supply Current	$V_{IN}=5.0\text{V}$, EN=L, No load		30	60	μA
I_{SHDN}	Shutdown Input Current	$V_{IN}=5.0\text{V}$, EN=H, No load		0.1	1	μA
I_{REV}	Reverse Leakage Current	$V_{OUT}=5.0\text{V}$, $V_{IN}=0\text{V}$		2	5	μA
V_{UVLO}	UVLO Threshold	V_{IN} rising		2	2.3	V
V_{UVLO_HY}	UVLO Hysteresis	V_{IN} falling		100		mV
EN/UVLO						
V_{EN_L}	EN Rising Threshold	$V_{IN}=5.0\text{V}$	1.5			V
V_{EN_H}	EN Falling Threshold	$V_{IN}=5.0\text{V}$			0.8	V
I_{EN}	EN Input Current	$V_{EN}=5.0\text{V}$ or 0V	-0.5	5	10	μA
OUTPUT						
I_{LIM}	Limit Current	$R_{LIM}=6.8\text{k}\Omega$	0.8	1	1.2	A
$V_{REVERSE}$	Reverse Voltage Protection	$V_{OUT}-V_{IN}$	5	20	50	mV
T_{RISE}	Output Rise Time	$C_L=1\mu\text{F}$, $R_L=100\text{ohm}$		0.1		ms
T_{FALL}	Output Fall Time	$C_L=1\mu\text{F}$, $R_L=100\text{ohm}$		0.3		ms
T_{IOS}	Short Circuit Response time			12		μs
R_{DIS}	OUT Discharge Resistance			10		Ω
Power Switch						
R_{DS_ON}		$I_{OUT}=1\text{A}$		60		m Ω
Thermal Shutdown						
T_{OTP}	Thermal Shutdown Threshold			150		$^{\circ}\text{C}$
T_{OTP_HY}	Thermal Shutdown Hysteresis			20		$^{\circ}\text{C}$

Product parametric performance is indicated in the Electrical Characteristics for the listed test conditions, unless otherwise noted.

Product performance may not be indicated by the electrical characteristics if operated under different conditions.

1. eFuse is latched off until the EN/Fault pin is pulled low and then released or a power on reset is applied to the device.
2. Does not include fan out of EN/Fault function.
3. Pulse test: Pulse width 300 s, duty cycle 2%.
4. Verified by design.

Characteristic plots

VDD=5V, TA=25°C

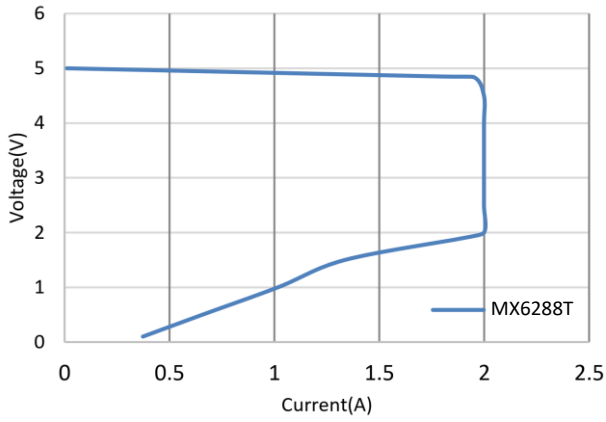

Output V-I curve

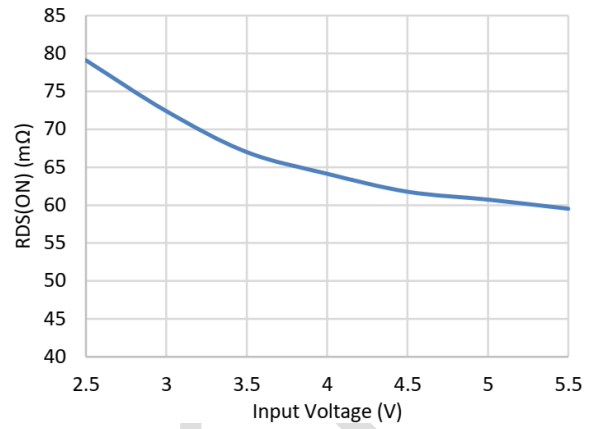

RDSON vs input voltage

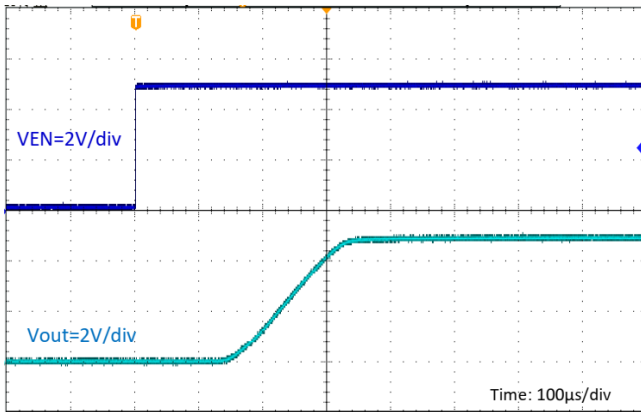

Enable response

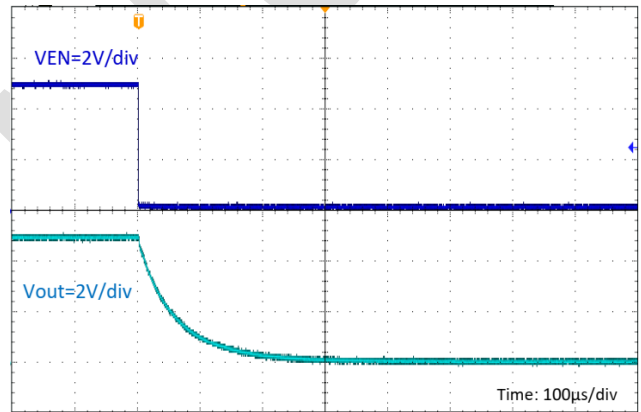

Disable response

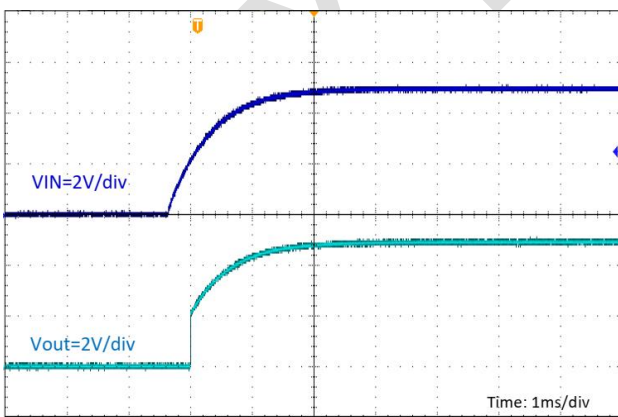

Input power on

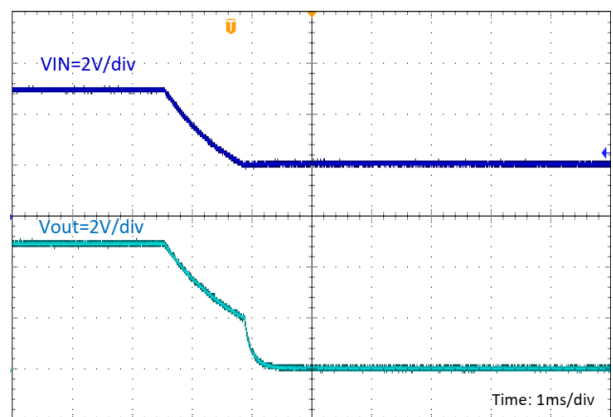

Input power off

Operation description

Overview

The MX6288T is current-limited, power distribution switches using P-channel MOSFETs for applications where short circuits or heavy capacitive loads will be encountered and provide up to 2.4A of continuous load current. Additional device shutdown features include over temperature protection and reverse-voltage protection. The driver controls the gate voltage of the power switch. The driver incorporates circuitry that controls the rise and fall times of the output voltage to limit large current and voltage surges and provides built-in soft-start functionality. The MX6288T enters constant current mode when the load exceeds the current-limit threshold.

Input and Output

IN (input) is the power supply connection to the logic circuitry and the drain of the output MOSFET. OUT(output) is the source of the output MOSFET. In a typical application, current flows through the switch from IN to OUT toward the load. OUT pin must be connected together to the load.

Soft Start for Hot Plug-In Application

In order to eliminate the upstream voltage droop caused by the large inrush current during hot-plug events, the “soft-start” feature effectively isolates the power source from extremely large capacitive loads, satisfying the USB voltage droop requirements.

Setting Current Limit

The over-current threshold is user programmable via an external resistor. The MX6288T use an internal regulation loop to provide a regulated voltage on the ILIM pin. The current-limit threshold is proportional to the current sourced out of ILIM. The recommended 1% resistor range for R_{ILIM} is $2.5k\Omega \leq R_{ILIM} \leq 17k\Omega$ to ensure stability of the internal regulation loop. Many applications require that the minimum current limit is above a certain current level or that the maximum current limit is below a certain current level, so it is important to consider the tolerance of the overcurrent threshold when selecting a value for R_{ILIM} . The following Figure 6 can be used to select the resulting type over-current threshold for a given external resistor value (R_{ILIM}).

$$I_{LIMIT} = 6800 / R_{ILIM}$$

MX6288T ensure that maximum Current Limit threshold is below 3A, it is important to avoid current limiting upstream power supplies causing the input voltage bus to drop.

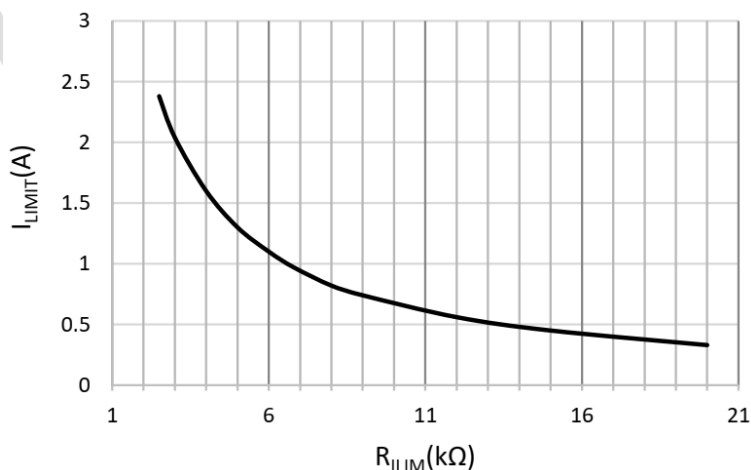

Thermal Shutdown

The MX6288T has internal over temperature protection to shut down the device when its junction temperature exceeds 150°C with over load current condition, then after the device is disabled, if the junction temperature drops 20°C hysteresis typically the device will resume and restart to work. The switch continues to cycle off and on until the over current fault is removed..

EN, the Enable Input

EN must be driven logic high or logic low for a clearly defined input. Floating the input may cause unpredictable operation, so please do not float EN input pin.

Layout

Layout Consideration

For best performance of the MX6288T, the following guidelines must be strictly followed.

- 1) Input and output capacitors should be placed close to the IC and connected to ground plane to reduce noise coupling.
- 2) The GND should be connected to a strong ground plane for heat sink.
- 3) Keep the main current traces as possible as short and wide.

SOT23-5 Package Information

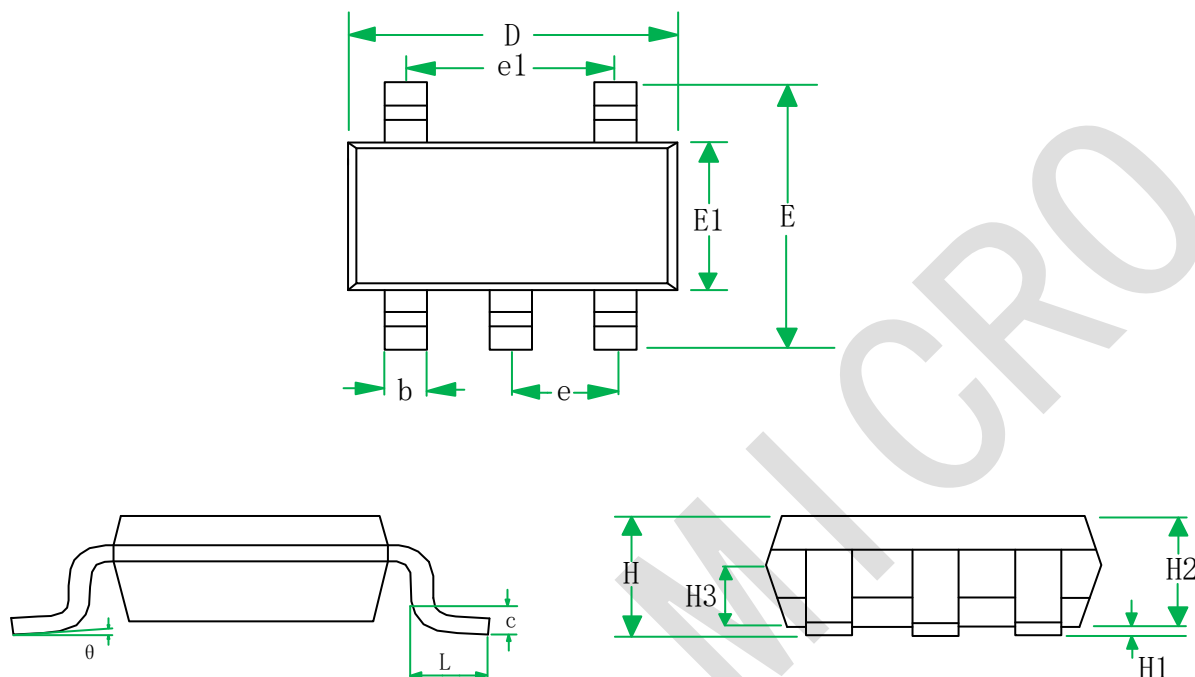

SOT23-5 for MX6288T

SYMBOL	MILLIMETERS			INCHES		
	MIN	NOM	MAX	MIN	NOM	MAX
H	1.07		1.25	0.042		0.049
H1	0.02	0.06	0.10	0.001	0.002	0.004
H2	1.05	1.10	1.15	0.041	0.043	0.045
H3	0.60	0.65	0.70	0.024	0.026	0.028
b	0.30	0.40	0.50	0.012	0.016	0.020
c	0.102	0.152	0.202	0.004	0.006	0.008
D	2.82	2.92	3.02	0.111	0.115	0.119
E	2.65	2.80	2.95	0.104	0.110	0.116
E1	1.50	1.60	1.70	0.059	0.063	0.067
e	0.95BSC			0.037BSC		
e1	1.90BSC			0.075BSC		
L	0.30	0.40	0.50	0.012	0.016	0.020
θ	0		8°	0		8°

Restrictions on Product Use

- ◆ MAXIN micro is continually working to improve the quality and reliability of its products. Nevertheless, semiconductor devices in general can malfunction or fail due to their inherent electrical sensitivity and vulnerability to physical stress. It is the responsibility of the buyer, when utilizing MAXIN products, to comply with the standards of safety in making a safe design for the entire system, and to avoid situations in which a malfunction or failure of such MAXIN products could cause loss of human life, bodily injury or damage to property.
- ◆ In developing your designs, please ensure that MAXIN products are used within specified operating ranges as set forth in the most recent MAXIN products specifications.
- ◆ The information contained herein is subject to change without notice.

MAXIN MICRO