

## GENERAL DESCRIPTION

MX1112AS is high performance offline PSR power switch for low power AC/DC charger and adapter applications. It operates in primary side sensing and regulation. Consequently, opto-coupler and TL431 could be eliminated. Proprietary constant voltage and constant current control is integrated as shown in the figure below.

In CC control, the current and output power setting can be adjusted externally by the sense resistor  $R_{cs}$  at CS pin. In CV control, multimode operations are utilized to achieve high performance and high efficiency. In addition, good load regulation is achieved by the built in cable drop compensation. Device operates in PFM in CC mode at large load condition and it operates in PWM with frequency reduction at light/medium load. The chip consumes very low operation current. It achieves less than 75mW standby power to meet strict standby power standard. MX1112AS offers comprehensive protection coverage with auto-retry feature including cycle-by-cycle current limiting, VDD over voltage protection, feedback loop open protection, short circuit protection, built-in leading edge blanking, VDD under voltage lockout and OTP etc.

MX1112AS is offered in SOP-8 package.

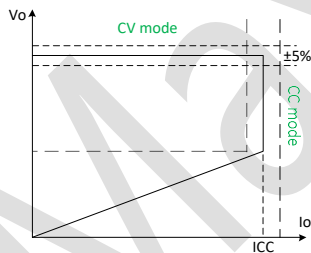

## Typical Application

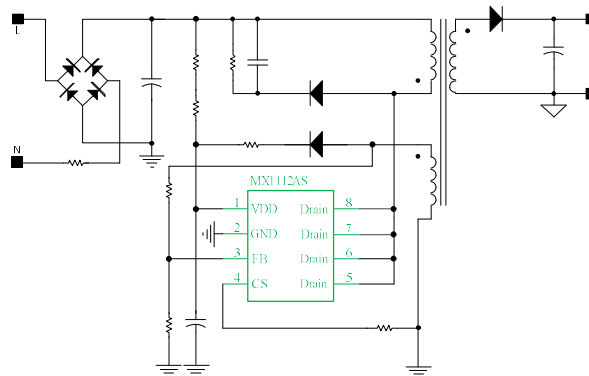

## FEATURES

- ◆ Primary side sensing and regulation without PC817 and TL431
- ◆ High precision CC and CV at universal AC input
- ◆ Multimode operation for efficiency improving
- ◆ 2A650V NMOSFET is integrated
- ◆ Programmable CC and CV regulation
- ◆ Built-in primary winding inductance compensation
- ◆ Programmable cable drop compensation
- ◆ No need for control loop compensation
- ◆ Audio noise free operation
- ◆ Ultra-low start up current and low operating current
- ◆ Built in leading edge blanking (LEB)
- ◆ Comprehensive protection coverage with auto-retry
  - VDD Under Voltage Lockout with hysteresis (UVLO)
  - VDD Over Voltage Protection (VDD OVP)
  - Cycle-by-cycle over current protection
  - Feedback loop open protection
  - Internal over temperature protection
  - Output short circuit protection

## Applications

Cell Phone Charger

Auxiliary Power Adapter for TV, PC etc.

Small Power Adapter

Digital Cameras Charger

## General information

### Ordering information

Part Number	Description
MX1112AS	SOP8, Halogen-free, RoHS

### Package dissipation rating

Package	R $\theta$ JA (°C/W)
SOP8	90

Note: Drain Pin Connected to 200mm<sup>2</sup> PCB copper clad.

### Absolute maximum ratings

Parameter	Value
Drain Voltage (off state)	650
VDD Voltage	30V
FB Input Voltage	-0.3 to 7V
CS Input Voltage	-0.3 to 7V
Min/Max Operating Junction Temperature T <sub>J</sub>	-40 to 150°C
Min/Max Storage Temperature T <sub>STG</sub>	-55 to 150°C
ESD(HBM)	±2kV
Lead Temperature (Soldering, 10secs)	260°C

Note: stresses beyond those listed under “absolute maximum ratings” may cause permanent damage to the device. These are stress ratings only, functional operation of the device at these or any other conditions beyond those indicated under “recommended operating conditions” is not implied. Exposure to absolute maximum rated conditions for extended periods may affect device reliability.

### Recommended operating condition

Symbol	Parameter	Range
VDD	VDD supply voltage	9-24V
PD	Power dissipation @TA=25°C	1.1W
Output power	Charger or adapter full AC input	12W

### Terminal assignments

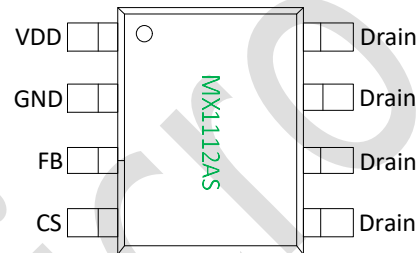

PIN NO.	PIN name	Description
1	VDD	Power supply.
2	GND	Ground pin.
3	FB	Input and output voltage are sensed from the auxiliary winding with a resistor divider.
4	CS	Current sense pin, connect resistors to ground external for cycle-by-cycle current limiting.
5、6、7、8	Drain	The Drain of the internal power MOSFET, connect the primary winding of transformer.

### Marking information

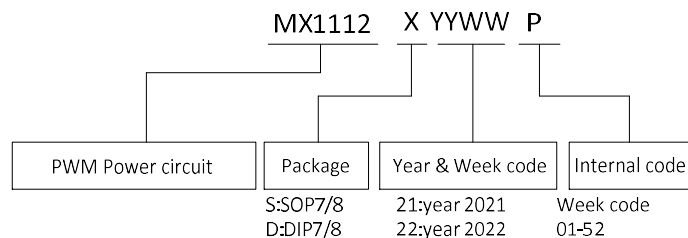

Block Diagram

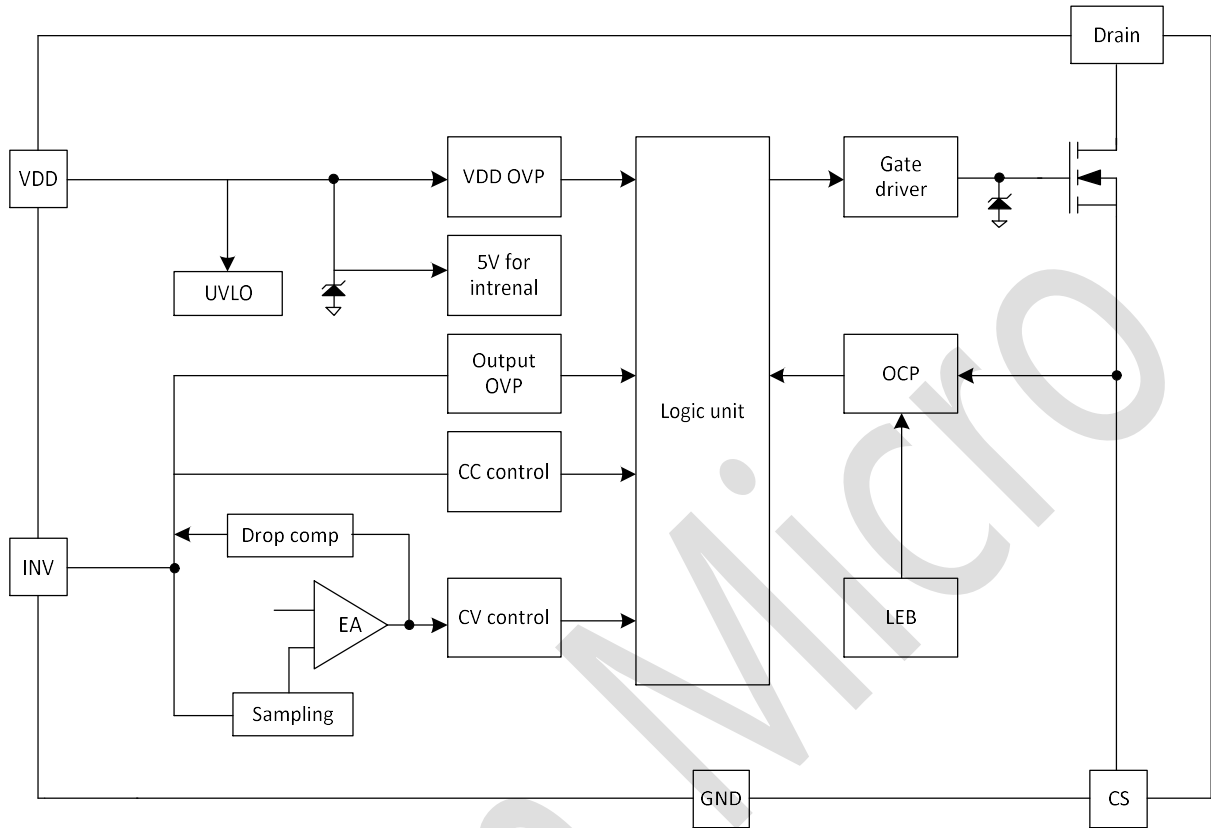

## Electrical characteristics

(TA=25°C, VDD=19V, unless otherwise noted)

Symbol	Parameter	Test condition	Min	Typ.	Max	Unit
<b>VDD supply voltage</b>						
I_startup	VDD startup current	VDD=UVLO_OFF-1V		5.0	20.0	μA
I_VDD	VDD normal operation current			0.85	1.0	mA
UVLO_ON	VDD under voltage lockout enter		7.3	8.3	9.3	V
UVLO_OFF	VDD under voltage lockout exit		15.5	16.5	17.5	V
V_OVP	Over voltage protection voltage		25.0	27.0	29.0	V
VDD_MAX	Maximum VDD voltage				25	V
<b>INV pin – Feedback input section</b>						
Vref_INV	Reference voltage for INV threshold		2.475	2.50	2.525	V
TOFF_MIN	Minimum off time			2.0		μs
FOSC_MIN	Minimum frequency		400	445	490	Hz
FOSC_MAX	Maximum frequency		72			kHz
I_CABLE	Maximum cable compensation current		40	45	50	μA
VO_OVP	Output over voltage threshold		2.85	3.0	3.15	V
<b>CS pin – Current sense input</b>						
VCS	Over current protection threshold		485	500	515	mV
VCS_MAX	Maximum over current threshold			590		mV
VCS_MIN	Over current threshold at light load			150		mV
T_LEB	Leading edge blanking time			300		ns
Td_OCP	OCP propagation delay time			100		ns
<b>MOSFET</b>						
RDS_ON	Static Drain to Source on resistance			3.3		Ω
VDS	Drain to Source breakdown voltage		650			V
<b>Internal OTP</b>						
OTP_in				145		°C

## Characteristic plots

VDD=19V

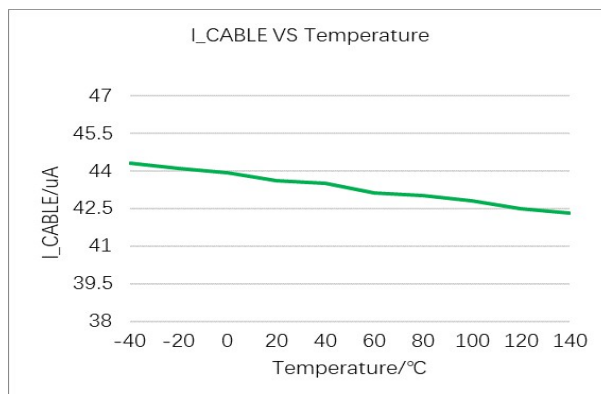
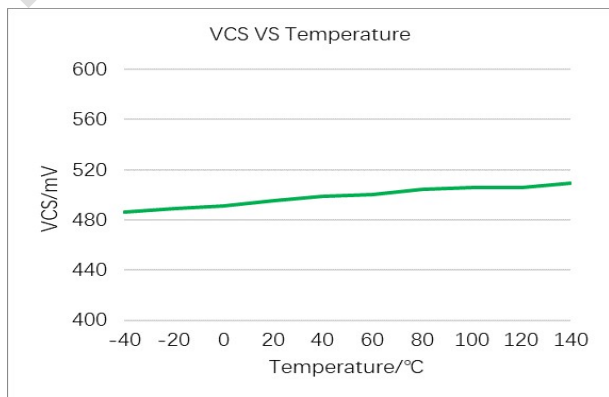
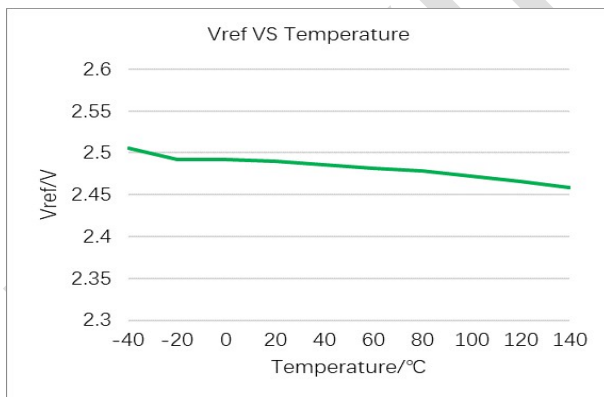
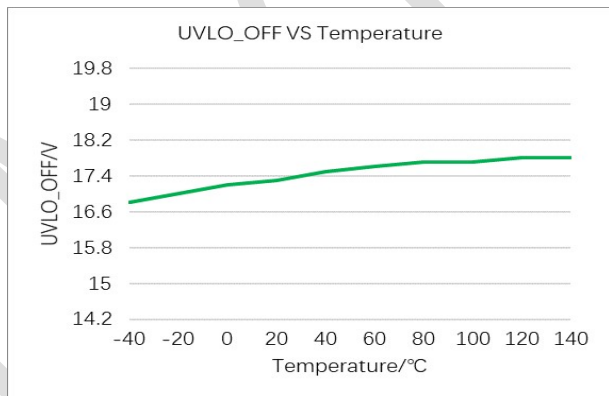
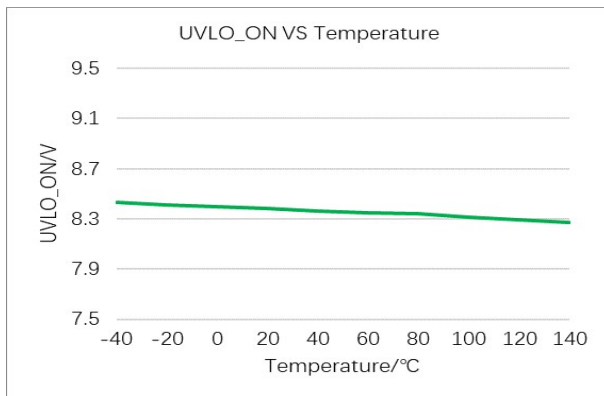
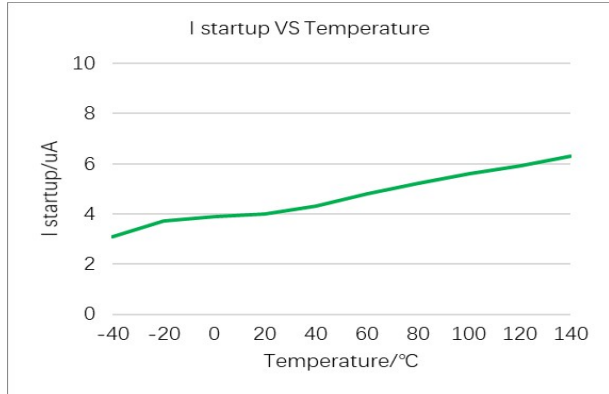
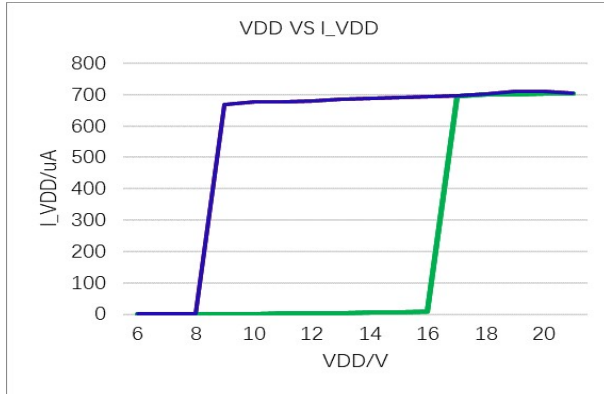

## Operation description

MX1112AS is a highly integrated current mode PWM power circuit, optimized for high performance, low standby power consumption. It operates in primary side sensing and regulation, thus opto-coupler and TL431 are not required. Proprietary built-in CV/CC control meeting most charger application.

### Startup current and Startup control

Startup current of MX1112AS is designed to be very low so that VDD could be charged up to UVLO\_OFF threshold level and device starts up quickly. A large value startup resistor can therefore be used to minimize the power loss yet achieve a reliable startup in application.

### Operation current

The typical operating current of MX1112AS is 0.85mA. Good efficiency is achieved with this low operating current. And less than 75mW standby power consumption can be achieved.

### CV/CC operation

MX1112AS is designed to produce good CV/CC control characteristic as shown in Figure1. In charger applications, a discharged battery charging starts in the CC portion of the curve until it is nearly full charged and smoothly switches to operate in CV portion of the curve. The CC portion provides output current limiting. In CV operation, the output voltage is regulated through the primary side control. In CC operation mode, MX1112AS will regulate the output current constant regardless of the output voltage drop.

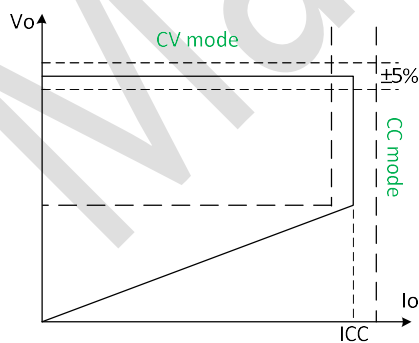

Figure1 typical CV/CC curve

### Principle of operation

To support MX1112AS series proprietary CV/CC control, system needs to be designed in DCM mode for flyback system.

In the DCM flyback converter, the output voltage can be sensed via the auxiliary winding. During MOSFET turn-on time, the load current is supplied from the output filter capacitor, Co, and the current in the primary winding ramps up. When MOSFET turns off, the energy stored in the primary winding is transferred to the secondary side and the current in the secondary side and the current in the secondary winding is

$$I_s = \frac{N_p}{N_s} \cdot I_p \quad (1)$$

The auxiliary voltage reflects the output voltage as shown in Figure2 and it is given by

$$V_{AUX} = \frac{N_{AUX}}{N_s} \cdot (V_o + V_{SD}) \quad (2)$$

Where  $V_{SD}$  is the voltage drop of the secondary Schottky Diode.

Via a resistor divider connected between the auxiliary winding and INV pin, the auxiliary voltage is sampled at the middle of the demagnetization and it is hold until the next sampling. The sampled voltage is compared with reference voltage  $V_{ref\_INV}$  and the difference is amplified. The error amplifier output reflects the load condition and controls the switching off time to regulate the output voltage, thus constant output voltage can be achieved. When the sampled voltage is below  $V_{ref\_INV}$  and the error amplifier output reaches its minimum, the switching frequency is controlled by sampled voltage to regulate the output current, thus the constant current can be achieved.

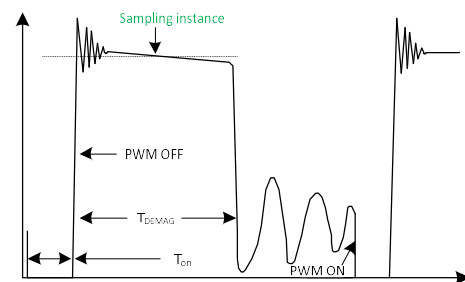

Figure2 Auxiliary winding waveform

### Adjustable CC point and output power

In MX1112AS series, the CC point and maximum output power can be externally adjusted by external current sense resistor  $R_{CS}$  at CS pin as illustrated in the typical application diagram. The larger  $R_{CS}$ , the smaller CC point is, and the smaller output power becomes, and vice versa as shown in Figure3.

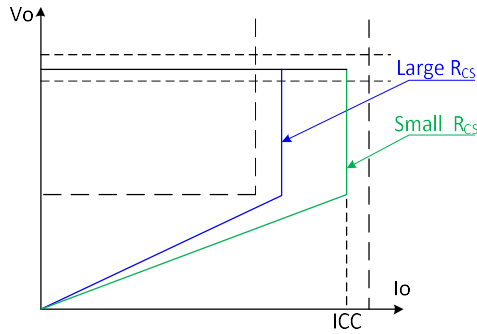

Figure3 adjustable output power by changing Rcs

### Operation switching frequency

The switching frequency of MX1112AS is adaptively controlled according to the load conditions and the operation modes.

For flyback operating in DCM, the maximum output power is given by

$$P_{O\_MAX} = \frac{1}{2} L_p \cdot I_p^2 \cdot F_{SW} \cdot \eta \quad (3)$$

Where  $L_p$  indicate the inductance of primary winding and  $I_p$  is the peak current of the primary winding,  $F_{sw}$  is the switching frequency and  $\eta$  is convert efficiency.

Refer to the equation 3, the change of the primary winding inductance results in the change of the maximum output power and the constant output current in CC mode. To compensation the change from variations of primary winding inductance, the switching frequency is locked by an internal loop and the switching frequency is

$$F_{SW} = \frac{1}{2 \cdot T_{DEMAG}} \quad (4)$$

Since  $T_{DEMAG}$  is inversely proportional to the inductance, as a result, the product  $L_p$  and  $F_{sw}$  is constant, thus the maximum output power and constant current in CC mode will not change as primary winding inductance changes. Up to  $\pm 7\%$  variation of the primary winding inductance can be compensated.

### On time OCP compensation

The variation of maximum output current in CC mode can be rather large if no compensation is provided. The OCP threshold value is self-adjusted higher at higher AC voltage. This OCP threshold slope adjustment helps to compensate the increased output current limit at higher AC voltage. In MX1112AS, a proprietary OCP compensation block is integrated and no external components are needed. The OCP threshold in MX1112AS series is a function of the switching

on time. For the on time between 1.6us to 6.4us, the OCP threshold changes linearly from 500mV to 590mV. For the on time larger than 6.4us, the OCP threshold is clamped to 590mV, as shown in Figure4.

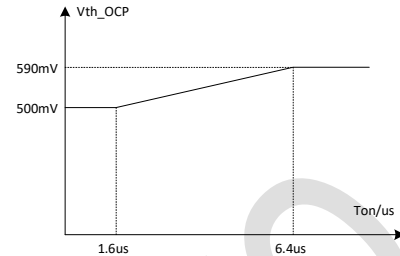

Figure4 OCP threshold compensation at on time

### Programmable cable drop compensation

In MX1112AS, cable drop compensation is implemented to achieve good load regulation, an offset voltage is generated at FB pin by an internal current flowing into the resistor divider. The current is proportional to the switching off time, as a result, it is inversely proportional to the output load current, and the drop due to the cable loss can be compensated. As the load current decreases from full load to no load, the offset voltage at FB pin will increase. It can also be programmed by adjusting the resistance of the divider to compensate the drop for various cable lines used as shown in Figure5.

The maximum compensation voltage is

$$\Delta V = \frac{I_{CABLE} \cdot (R_U // R_D) \cdot 10^{-6}}{2.5} \cdot V_o \quad (5)$$

Where  $\Delta V$  is load compensation voltage and  $V_o$  is output voltage. For example:  $V_o$  is 5V,  $R_U // R_D$  is 4.7Kohm, the maximum load compensation voltage is

$$\Delta V = \frac{45 \times 4700 \times 10^{-6}}{2.5} \times 5.0 = 0.423V$$

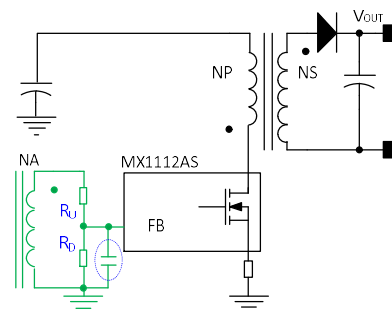

Figure5 Application with FB pin

In addition, when the MOSFET just turns off, leakage inductance of the transformer and parasitic capacitance of the MOSFET induces resonant oscillations on the FB pin.

The resonant oscillations may cause the MX1112AS to falsely trigger FB over voltage protection, which thus fails to reflect actual output over voltage fault condition so that the circuit may not function properly. As load increases, the duration of the resonant oscillation may also increase. A small bypass capacitor which sized from 10-47pF and placed as close to the FB pin as possible is recommended to be added to suppress such noises on the FB pin as shown in Figure5.

#### **Current sensing and leading edge blanking**

Cycle-by Cycle current limiting is offered in MX1112AS. The switch current is detected by a sense resistor into the CS pin. An internal leading edge blanking circuit chops off the sensed voltage spike at initial power MOSFET on state so that the external RC filtering on sense input is no longer needed.

#### **Gate driver internal**

The GATE pad is connected to the gate of a power MOSFET internal. An internal 11V clamp is added for MOSFET gate protection at high VDD voltage. When VDD voltage drops below UVLO, the gate pad is internally pull low to maintain the off state.

#### **Protection control**

Good power supply system reliability is achieved with its rich protection features including precise on-chip OTP, cycle-by cycle current limiting, output over voltage protection, VDD over voltage protection, short circuit protection, under voltage lockout on VDD.



Package information

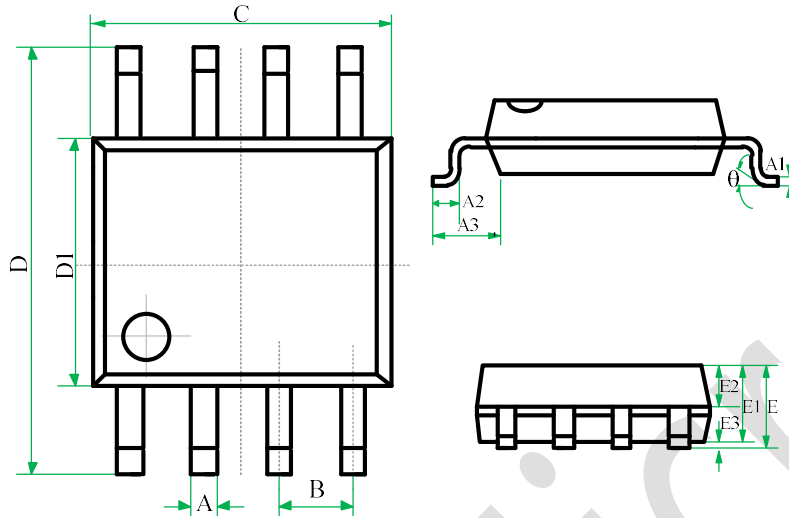

SYMBOL	MILLIMETERS			INCHES		
	MIN	NOM	MAX	MIN	NOM	MAX
A	0.39	-	0.48	0.0154	-	0.0189
A1	0.21	-	0.28	0.008	-	0.011
A2	0.50	-	0.80	0.020	-	0.031
A3	1.05BSC			0.041BSC		
B	1.27BSC			0.050BSC		
C	4.70	4.90	5.10	0.185	0.193	0.201
D	5.80	6.00	6.20	0.228	0.236	0.244
D1	3.70	3.90	4.10	0.146	0.154	0.161
E	-	-	1.75	-	-	0.069
E1	1.30	1.40	1.50	0.051	0.055	0.059
E2	0.60	0.65	0.70	0.024	0.026	0.028
E3	0.10	-	0.225	0.004	-	0.009
θ	0	-	8°	0	-	8°

SOP8 for MX1112AS

## Restrictions on Product Use

- ◆ MAXIN micro is continually working to improve the quality and reliability of its products. Nevertheless, semiconductor devices in general can malfunction or fail due to their inherent electrical sensitivity and vulnerability to physical stress. It is the responsibility of the buyer, when utilizing MAXIN products, to comply with the standards of safety in making a safe design for the entire system, and to avoid situations in which a malfunction or failure of such MAXIN products could cause loss of human life, bodily injury or damage to property.
- ◆ In developing your designs, please ensure that MAXIN products are used within specified operating ranges as set forth in the most recent MAXIN products specifications.
- ◆ The information contained herein is subject to change without notice.